

SR2/SR3 Series

3-Phase, Detachable/Integrated Heatsink Type SSR

■ Features

- Two mounting hole types and sizes
- Alarm function (overheat prevention)
 - : Alarm indicator (red LED), disconnect standard output, alarm output
- Dielectric strength: 4000 VAC (also 2,500VAC model)
- High heat dissipation efficiency with ceramic PCB and integrated heatsink
- Zero cross turn-on, random turn-on models available
- Input indicator (green LED)
- Various mounting methods (DIN rail, panel) - SRH2/SRH3 series
 - *DIN rail mount not available for 50 A, 75 A load current models

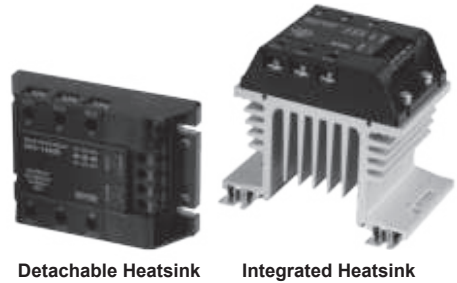

⚠ Please read "Safety Considerations" in operation manual before using.



■ Ordering Information

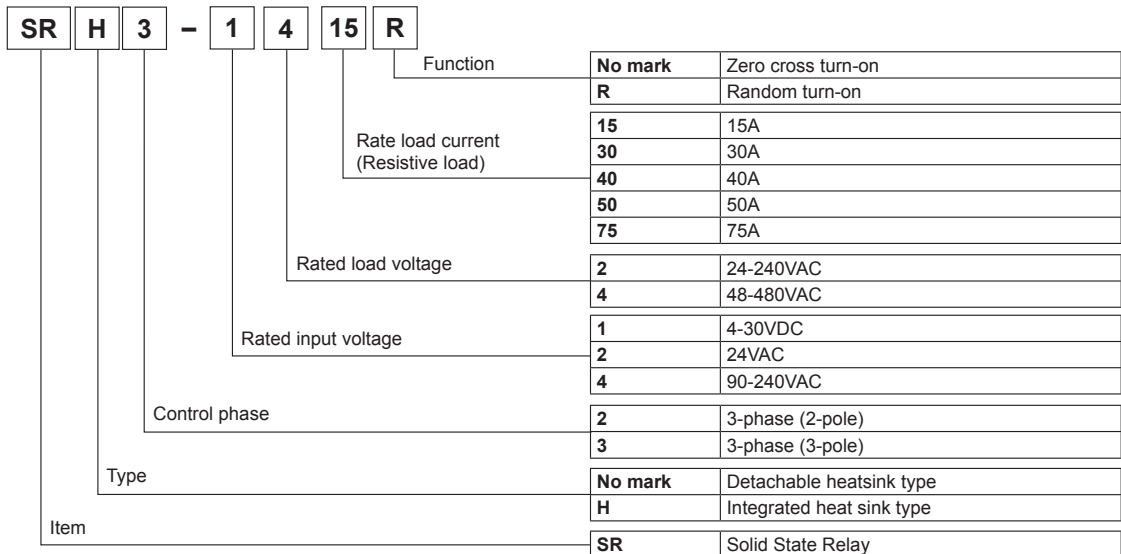

Model	Rated input voltage	Rated load current	Rated load voltage	Function
SR(H)2-1215	4-30VDC	15A	24-240VAC	Zero cross turn-on
SR(H)3-1215				
SR(H)2-4215	90-240VAC	30A		
SR(H)3-4215				
SR(H)2-1230	4-30VDC	50A		
SR(H)3-1230				
SR(H)2-4230	90-240VAC	75A		
SR(H)3-4230				
SR(H)2-1250	4-30VDC	75A		
SR(H)3-1250				
SR(H)2-4250	90-240VAC	75A		
SR(H)3-4250				
SR(H)2-1275	4-30VDC	75A		
SR(H)3-1275				
SR(H)2-4275	90-240VAC	75A		
SR(H)3-4275				

3-Phase, Detachable/Integrated Heatsink Type SSR

Model	Rated input voltage	Rated load current	Rated load voltage	Function
SR(H)2-1415	4-30VDC	15A	48-480VAC	Zero cross turn-on
SR(H)3-1415				Random turn-on
SR(H)2-1415R				Zero cross turn-on
SR(H)3-1415R				Zero cross turn-on
SR(H)2-2415	24VAC			Zero cross turn-on
SR(H)3-2415	Zero cross turn-on			
SR(H)2-4415	90-240VAC			Zero cross turn-on
SR(H)3-4415	Zero cross turn-on			
SR(H)2-1430	4-30VDC	30A		Zero cross turn-on
SR(H)3-1430				Random turn-on
SR(H)2-1430R				Zero cross turn-on
SR(H)3-1430R				Random turn-on
SR(H)2-2430	24VAC			Zero cross turn-on
SR(H)3-2430	Zero cross turn-on			
SR(H)2-4430	90-240VAC			Zero cross turn-on
SR(H)3-4430	Zero cross turn-on			
SR(H)2-1440	4-30VDC	40A		Zero cross turn-on
SR(H)3-1440				Random turn-on
SR(H)2-1440R				Zero cross turn-on
SR(H)3-1440R				Random turn-on
SR(H)2-2440	24VAC			Zero cross turn-on
SR(H)3-2440	Zero cross turn-on			
SR(H)2-4440	90-240VAC			Zero cross turn-on
SR(H)3-4440	Zero cross turn-on			
SR(H)2-1450	4-30VDC	50A	Zero cross turn-on	
SR(H)3-1450			Random turn-on	
SR(H)2-1450R			Zero cross turn-on	
SR(H)3-1450R			Random turn-on	
SR(H)2-2450	24VAC		Zero cross turn-on	
SR(H)3-2450	Zero cross turn-on			
SR(H)2-4450	90-240VAC		Zero cross turn-on	
SR(H)3-4450	Zero cross turn-on			
SR(H)2-1475	4-30VDC	75A	Zero cross turn-on	
SR(H)3-1475			Random turn-on	
SR(H)2-1475R			Zero cross turn-on	
SR(H)3-1475R			Random turn-on	
SR(H)2-2475	24VAC		Zero cross turn-on	
SR(H)3-2475	Zero cross turn-on			
SR(H)2-4475	90-240VAC		Zero cross turn-on	
SR(H)3-4475	Zero cross turn-on			

- (A) Photoelectric Sensors
- (B) Fiber Optic Sensors
- (C) Door/Area Sensors
- (D) Proximity Sensors
- (E) Pressure Sensors
- (F) Rotary Encoders
- (G) Connectors/ Connector Cables/ Sensor Distribution Boxes/Sockets
- (H) Temperature Controllers
- (I) SSRs / Power Controllers
- (J) Counters
- (K) Timers
- (L) Panel Meters
- (M) Tacho / Speed / Pulse Meters
- (N) Display Units
- (O) Sensor Controllers
- (P) Switching Mode Power Supplies
- (Q) Stepper Motors & Drivers & Controllers
- (R) Graphic/ Logic Panels
- (S) Field Network Devices
- (T) Software

■ Specifications

◎ Input

Rated input voltage range	4-30VDC \equiv	24VACrms \sim (50/60Hz)	90-240VACrms \sim (50/60Hz)
Input voltage range	4-32VDC \equiv	19-26.4VACrms \sim (50/60Hz)	85-264VACrms \sim (50/60Hz)
Max. input current	25mA	15mA	25mA
Pick-up voltage	Min. 4VDC \equiv	Min. 19VACrms \sim	Min. 85VACrms \sim
Drop-out voltage	Max. 1VDC \equiv	Max. 4VACrms \sim	Max. 10VACrms \sim
Turn-on time	Zero cross turn-on	Max. 0.5 cycle of load source + 1ms	Max. 1.5 cycle of load source + 1ms
	Random turn-on	Max. 1ms	—
Turn-off time	Max. 0.5 cycle of load source + 1ms	Max. 1.5 cycle of load source + 1ms	Max. 1.5 cycle of load source + 1ms

SR2/SR3 Series

■ Specifications

◎ Output

Rated load voltage range	24-240VACrms~ (50/60Hz)				48-480VACrms~ (50/60Hz)					
Load voltage range	24-264VACrms~ (50/60Hz)				48-528VACrms~ (50/60Hz)					
Rated load current	Resistive load (AC-51) ^{※1}	15Arms	30Arms	50Arms	75Arms	15Arms	30Arms	40Arms	50Arms	75Arms
Min. load current		0.15Arms	0.2Arms	0.5Arms		0.5Arms				
Max. 1 cycle surge current (60Hz)		250A	400A	1000A		300A	500A		1000A	
Max. non-repetitive surge current (I ² t, t=8.3ms)		340A ² S	1000A ² S	4000A ² S		350A ² S	1000A ² S		4000A ² S	
Peak voltage (non-repetitive)		600V				1200V (Zero cross turn-on), 1000V (Random turn-on)				
Leakage current (Ta=25°C)		Max. 10mArms (240VAC~/60Hz)				Max. 10mArms (480VAC~/60Hz)				
Output on voltage drop [Vpk] (max. load current)		Max. 1.6V								
Static off-state dv/dt		500V/μs								

※1: AC-51 is utilization category at IEC 60947-4-3.

◎ Alarm output (overheat prevention)

Rated input voltage range	4-30VDC≡	24VACrms~ (50/60Hz)	90-240VACrms~ (50/60Hz)
Load input voltage	Max. 30VDC≡	Max. 30VDC≡	Max. 30VDC≡
Load input current	Max. 100mA	Max. 50mA	Max. 50mA
Turn-off time	Max. 20ms	Max. 40ms	Max. 40ms

※Overheat prevention function: When SSR internal temperature is overheated, the load output is cut off to prevent internal device damage. The alarm indicator turns ON and alarm output turns ON.

※To clear alarm, cut OFF the input signal during over alarm output return time at the rated ambient temperature.

◎ General specifications

Dielectric strength (Vrms)	<ul style="list-style-type: none"> ● 24-240VAC~ rated load current 15A/30A : 2500VAC 50/60Hz 1 min (input-output, input/output-case) ● 24-240VAC~ rated load current 50A/75A ● 48-480VAC~ rated load current 15A/30A/40A/50A/75A : 4000VAC 50/60Hz 1 min (input-output, input/output-case) 	
	Insulation resistance	Over 100MΩ (at 500VDC megger) (input-output, input/output-case)
Indicator	Input indicator: Green LED / Alarm indicator: Red LED	
Vibration	Mechanical	0.75mm amplitude at frequency of 10 to 55Hz (for 1 min) in each X, Y, Z direction for 1 hour
	Malfunction	0.5mm amplitude at frequency of 10 to 55Hz (for 1 min) in each X, Y, Z direction for 10 min
Shock	Mechanical	300m/s ² (approx. 30G) in each X, Y, Z direction for 3 times
	Malfunction	100m/s ² (approx. 30G) in each X, Y, Z direction for 3 times
Environment	Ambient temperature	-30 to 80°C (in case of the rated input voltage 90-240VAC~: -30 to 70°C), Storage: -30 to 100°C (The rated load current capacity is different depending on ambient temperature. Refer to '■ SSR Derating Curve'.)
	Ambient humidity	45 to 85%RH, Storage: 45 to 85%RH
Input terminal connection, alarm output terminal connection	Min. 1×0.5mm ² (1×AWG 20), max. 1×1.5mm ² (1×AWG 16) or 2×1.5mm ² (2×AWG 16)	
Output terminal connection	Min. 1×1.5mm ² (1×AWG 16), max. 1×16mm ² (1×AWG 6) or 2×6mm ² (2×AWG 10) ※Use wires compliant with load current capacity to connect to the terminal.	
Input terminal fixed torque	0.75 to 0.95N·m	
Output terminal fixed torque	1.6 to 2.2N·m	
Approval		
Weight ^{※1}	<ul style="list-style-type: none"> ● Detachable heatsink type: approx. 365g (approx. 275g) ● Integrated heat sink type - Rated load current 15A/30A/40A: approx. 896g (approx. 686g) Rated load current 50A: approx. 1508g (approx. 1268g) Rated load current 75A: approx. 2354g (approx. 2064g) 	

※1: The weight includes packaging. The weight in parenthesis is for unit only.

※Environment resistance is rated at no freezing or condensation.

※For wiring the terminal, round terminal must be used.

3-Phase, Detachable/Integrated Heatsink Type SSR

■ Dimensions

(unit: mm)

◎ Detachable heatsink type

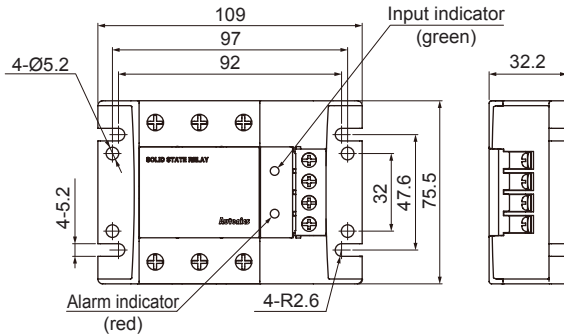

• Panel cut-out

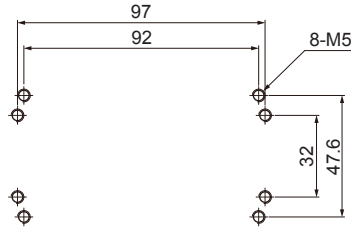

※Detachable heatsink type screw tightening torque for mounting : 2.5N·m to 3N·m

◎ Integrated heat sink (rated load current 15A/30A/40A)

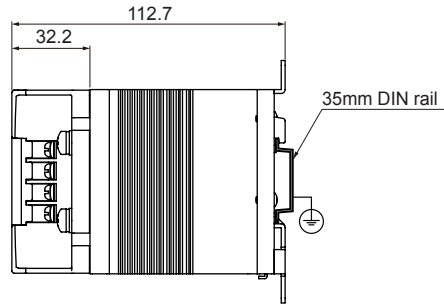
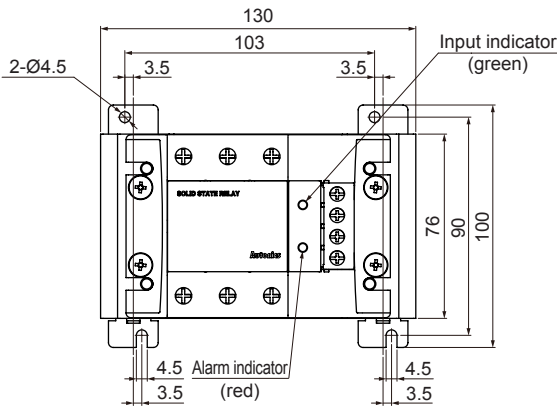

※DIN rail must be grounded.

• Cooling fan mounting hole (rated load current 30A/40A)

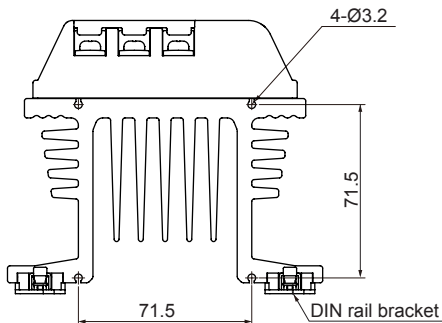

• Panel cut-out

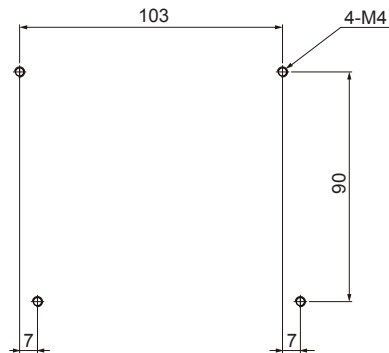

※Integrated heatsink type screw tightening torque for mounting: 1.35N·m

※When installing multiple SSRs, please keep space between SSRs for heat radiation.

When installing SSRs horizontally (input part and output part on the same height), please supply less than 50% of the rated load current.

(A)	Photoelectric Sensors
(B)	Fiber Optic Sensors
(C)	Door/Area Sensors
(D)	Proximity Sensors
(E)	Pressure Sensors
(F)	Rotary Encoders
(G)	Connectors/ Connector Cables/ Sensor Distribution Boxes/Sockets
(H)	Temperature Controllers
(I)	SSRs / Power Controllers
(J)	Counters
(K)	Timers
(L)	Panel Meters
(M)	Tacho / Speed / Pulse Meters
(N)	Display Units
(O)	Sensor Controllers
(P)	Switching Mode Power Supplies
(Q)	Stepper Motors & Drivers & Controllers
(R)	Graphic/ Logic Panels
(S)	Field Network Devices
(T)	Software

SR2/SR3 Series

◎ Integrated heat sink (rated load current 50A)

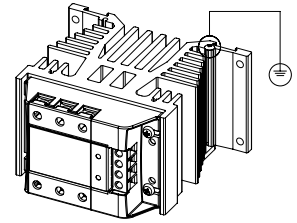
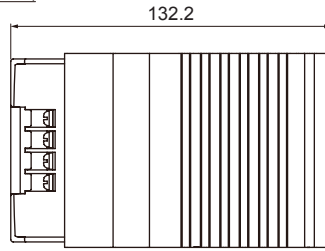
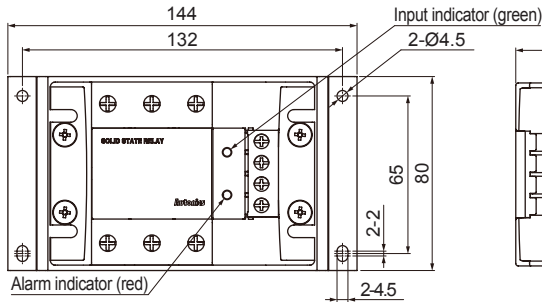

※Bolts for grounding must be grounded.

• Cooling fan mounting hole

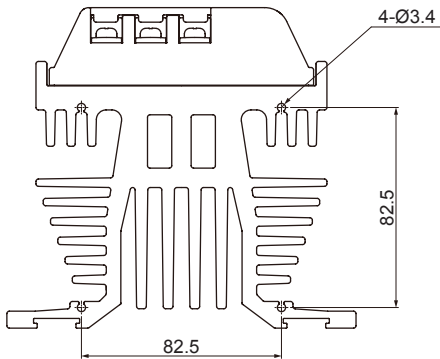

• Panel cut-out

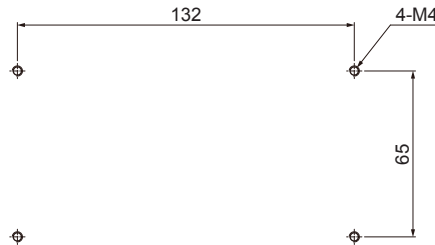

◎ Integrated heat sink (rated load current 75A)

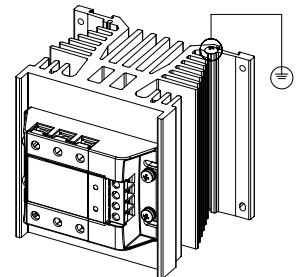
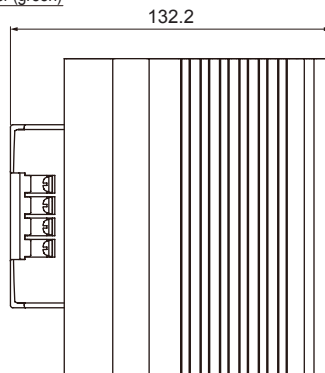
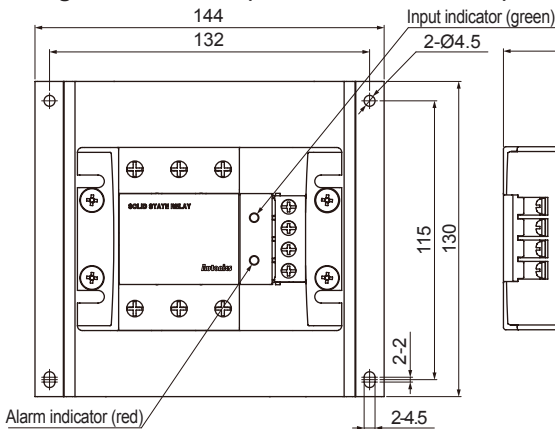

※Bolts for grounding must be grounded.

• Cooling fan mounting hole

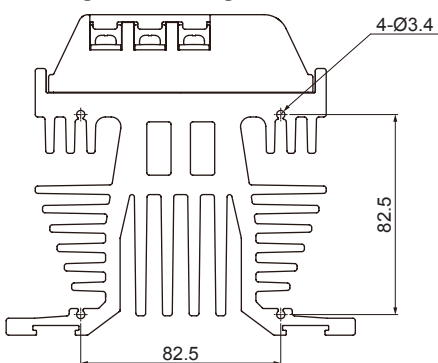

• Panel cut-out

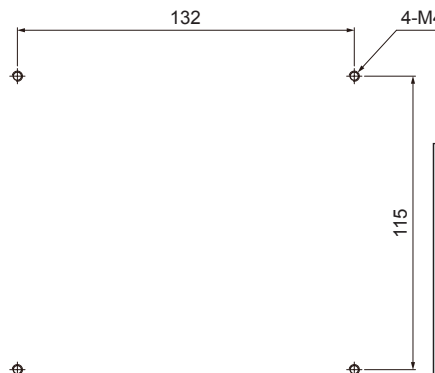

⚠ High temperature caution

While supplying power to the load or right after turning off the power of the load, do not touch the body and heat sink. Failure to follow this instruction may result in a burn due to the high temperature.

※Integrated heatsink type screw tightening torque for mounting: 1.35N·m

※When installing multiple SSRs, please keep space between SSRs for heat radiation.

When installing SSRs horizontally (input part and output part on the same height), please supply less than 50% of the rated load current.

3-Phase, Detachable/Integrated Heatsink Type SSR

Connections

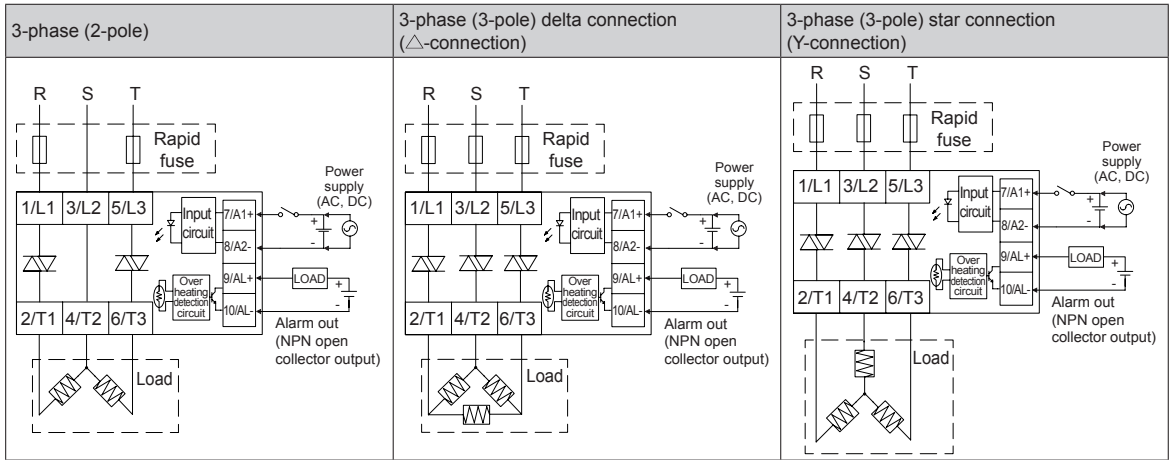

※For DC signal input models, 8 and 10 terminals are connected inside.
 ※For AC signal input models, 8 and 10 terminals are insulated inside.
 ※Use terminals of size specified below.

Terminal type	Input	Output
 <Round>	a	Min. 3.5mm
	b	Max. 7.0mm
		Min. 5.0mm
		Max. 12.0mm

SSR Derating Curve

◎ SR(H)2/SR(H)3-1215

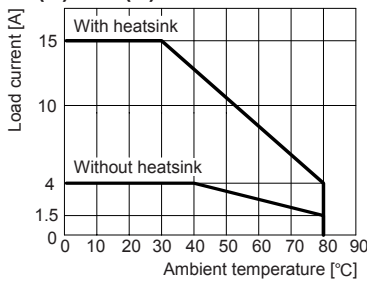

◎ SR(H)2/SR(H)3-1415/1415R/2415

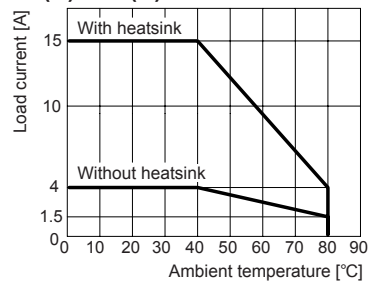

◎ SR(H)2/SR(H)3-4215

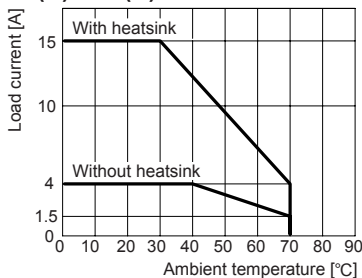

◎ SR(H)2/SR(H)3-4415

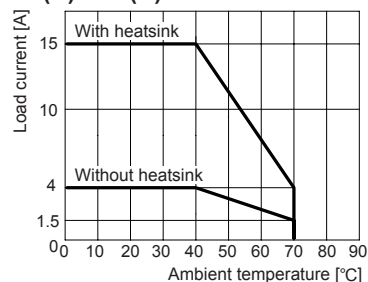

◎ SR(H)2/SR(H)3-1230

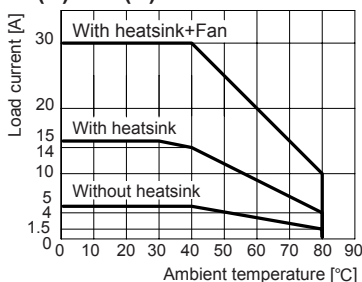

◎ SR(H)2/SR(H)3-1430/1430R/2430

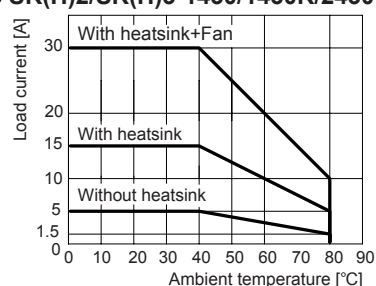

- (A) Photoelectric Sensors
- (B) Fiber Optic Sensors
- (C) Door/Area Sensors
- (D) Proximity Sensors
- (E) Pressure Sensors
- (F) Rotary Encoders
- (G) Connectors/ Connector Cables/ Sensor Distribution Boxes/Sockets
- (H) Temperature Controllers
- (I) SSRs / Power Controllers
- (J) Counters
- (K) Timers
- (L) Panel Meters
- (M) Tacho / Speed / Pulse Meters
- (N) Display Units
- (O) Sensor Controllers
- (P) Switching Mode Power Supplies
- (Q) Stepper Motors & Drivers & Controllers
- (R) Graphic/ Logic Panels
- (S) Field Network Devices
- (T) Software

SR2/SR3 Series

■ SSR Derating Curve

◎ SR(H)2/SR(H)3-4230

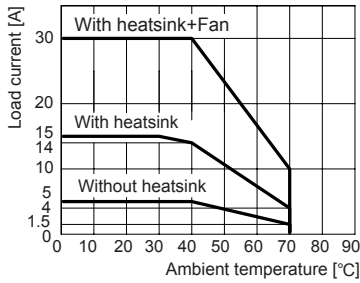

◎ SR(H)2/SR(H)3-4430

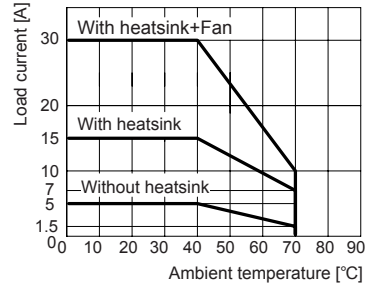

◎ SR(H)2/SR(H)3-1440/1440R/2440

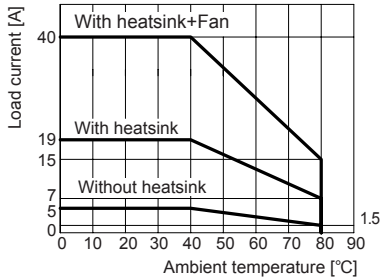

◎ SR(H)2/SR(H)3-4440

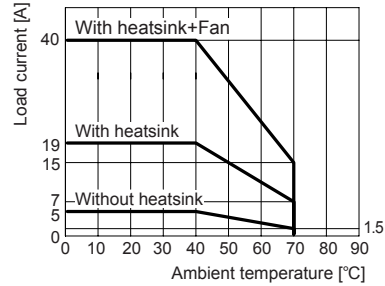

◎ SR(H)2/SR(H)3-1250/1450/1450R/2450

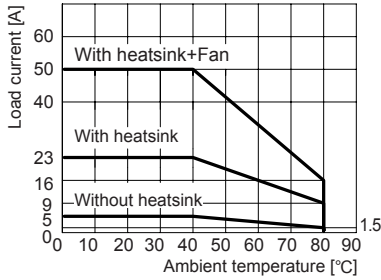

◎ SR(H)2/SR(H)3-4250/4450

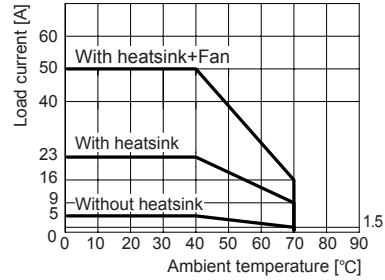

◎ SR(H)2/SR(H)3-1275/1475/1475R/2475

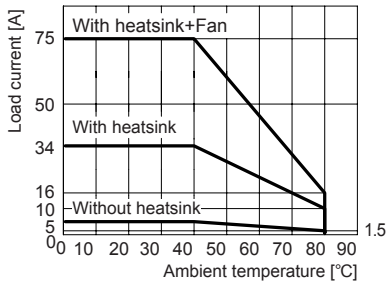

◎ SR(H)2/SR(H)3-4275/4475

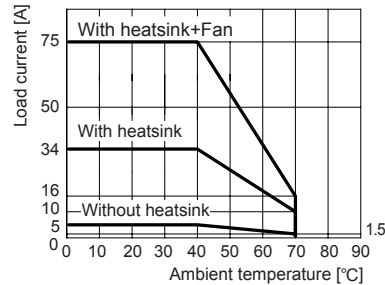

※ The heatsink of the curves is dedicated for the SRH2/SRH3.

※ Install SR2/SR3 Series on the metal plate (min. 130mm×120mm).

△ Since effectiveness of the heat radiation is decreased when multiple SSRs are installed closely, please supply less than 50% of the rated load current.

※ Above SSR derating curves obtained approval from the UL certification authority.

◎ Specification of cooling fan

Load capacity	Cooling fan type	Size (mm)	Rated air flow ^{※1}	
			m ³ /min	CFM
30A/40A	AC Fan	80×80	0.68	24.0
	DC Fan		1.25	44.0
50A/75A	AC Fan	92×92	1.13	40.0
	DC Fan		1.80	63.5

※1: The cooling fan should be over the rated air flow value.

※ Autonics does not provide or sell a cooling fan. (Please buy a cooling fan separately.)

3-Phase, Detachable/Integrated Heatsink Type SSR

■ Proper Usage

⚠ Cautions during use

1. Follow instructions in 'Cautions during Use'. Otherwise, it may cause unexpected accidents.
2. 4-30VDC, 24VAC signal input should be insulated and limited voltage/current or Class 2, SELV power supply device.
3. Attach a heat sink or install the unit in the well ventilated place.
To attach the heat sink, use Thermal Grease as below or that of equal specification.
※Thermal Grease: GE TOSHIBA (YG6111), KANTO-KASEI (FLOIL G-600), SHINETSU (G746)
4. Ground to the heat sink, panel, or DIN rail. Failure to follow this instruction may result in electric shock.
5. While supplying power to the load or right after turning off the power of the load, do not touch the body and heat sink. Failure to follow this instruction may result in a burn due to the high temperature.
6. In order to protect the product from the short-circuit current of the load, use rapid fuse of which I²t is under the 1/2 of SSR I²t. When short-circuited, replace the fuse to those of same specification with the used rapid fuse.
7. Install dummy resistance in parallel with the load, to keep the sum of current flowing in the load and dummy resistance being over SSR minimum load current.
8. When using random turn-on model for phase control, install noise filter between the load and the power of the load.
9. Do not use near the equipment which generates strong magnetic force or high frequency noise.
10. This unit may be used in the following environments.
 - ① Indoors (in the environment condition rated in 'Specifications')
 - ② Altitude max. 2,000m
 - ③ Pollution degree 2
 - ④ Installation category III

(A)
Photoelectric
Sensors

(B)
Fiber
Optic
Sensors

(C)
Door/Area
Sensors

(D)
Proximity
Sensors

(E)
Pressure
Sensors

(F)
Rotary
Encoders

(G)
Connectors/
Connector Cables/
Sensor Distribution
Boxes/Sockets

(H)
Temperature
Controllers

(I)
SSRs / Power
Controllers

(J)
Counters

(K)
Timers

(L)
Panel
Meters

(M)
Tacho /
Speed / Pulse
Meters

(N)
Display
Units

(O)
Sensor
Controllers

(P)
Switching
Mode Power
Supplies

(Q)
Stepper Motors
& Drivers
& Controllers

(R)
Graphic/
Logic
Panels

(S)
Field
Network
Devices

(T)
Software